

ORDER INFORMATION AND DIMENSION:

Circuits	Part No. (Light ivory color, T/P)	Dimension	
		A	B
2	2542P02 00T	2.54	5.1
3	2542P03 00T	5.08	7.6
4	2542P04 00T	7.62	10.2
5	2542P05 00T	10.16	12.7
6	2542P06 00T	12.70	15.2
7	2542P07 00T	15.24	17.8
8	2542P08 00T	17.78	20.3
9	2542P09 00T	20.32	22.9
10	2542P10 00T	22.86	25.4
11	2542P11 00T	25.40	27.9
12	2542P12 00T	27.94	30.5
13	2542P13 00T	30.48	33.0
14	2542P14 00T	33.02	35.6
15	2542P15 00T	35.56	38.1

DESCRIPTION OF ORDER NO.:

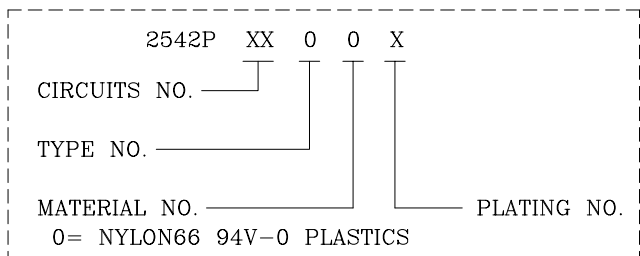

NOTES:

- MATERIAL:  
BASE: NYLON66 94V-0, LIGHT IVORY COLOR (NATURAL)  
CONTACT PIN: BRASS
- MATES WITH 2540S SINGLE-ROW SERIES PLUG HOUSING.
- DESCRIPTION OF COLOR CODE:  
LEGEND: 2542PXX00X-X (-X: COLOR CODE)  
B=BLACK, C=COCONUT BROWN, D=ORANGE, E=BLUE, H=GRAY,  
I=BRICK RED, K=PURPLE, L=LEMON YELLOW, M=GREEN,  
P=PINK, R=RED, V=LAVENDER, W=BROWN, Y=YELLOW
- INFORMATION IN THIS DRAWING IS NOT CONSIDERED AS FINAL.

DESCRIPTION OF PLATING CODE:	
T= TIN-PLATED (T/P)	1= GOLD FLASH-PLATED
V= MATTE TIN-PLATED	

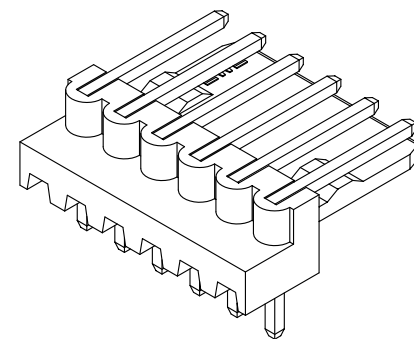
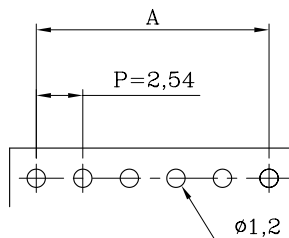
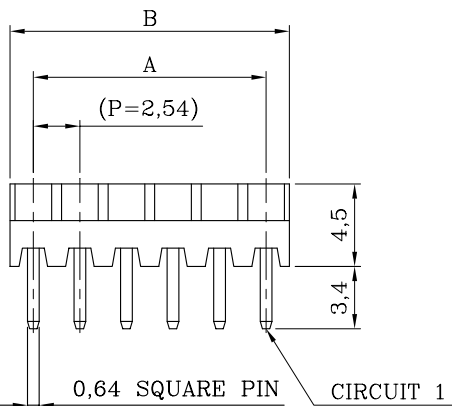
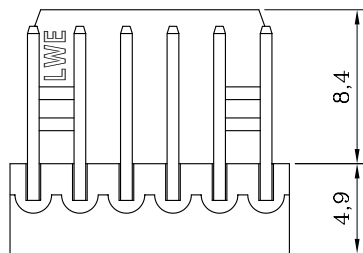

ISOMETRIC VIEW

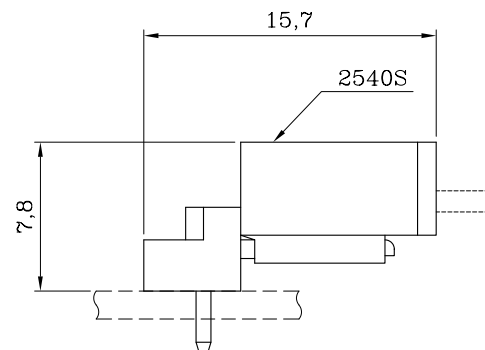
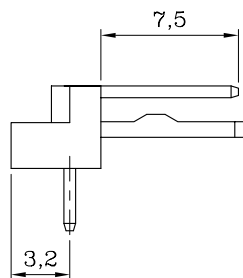

ASSEMBLY LAYOUT

P.C. BOARD LAYOUT  
(COMPONENT SIDE)

MATERIAL: SEE NOTES		FINISH(COLOR): SEE NOTES	
W1	NEW RELEASE	31-DEC-14'	ANGULAR ±3°
REV.	REVISION RECORD	DATE	

		Sales Drawing			
聯盈電子股份有限公司 LANDWIN ELECTRONIC CORP.					
GENERAL TOLERANCE:	PROJECTION	SCALE	UNIT	SHEET NO.	REV
		FREE	MM	1 / 1	W1
	DRAWN R.G.	DRAW NO.			
	CHECKED J.L.Lin	(CQ) 2542PXX00X			
	APPD H.Y.Lin	TITLE:			
	DATE 31-DEC-14'	2.54 PITCH SINGLE-ROW RIGHT-ANGLE DIP-HEADER			