

ORDER INFORMATION AND DIMENSION:

Circuits	Part No. (Matte tin-plated)	Dimension	
		A	B
2	3002P02 19V	3.00	9.7
3	3002P03 19V	6.00	12.7
4	3002P04 19V	9.00	15.7
5	3002P05 19V	12.00	18.7
6	3002P06 19V	15.00	21.7
7	3002P07 19V	18.00	24.7
8	3002P08 19V	21.00	27.7
9	3002P09 19V	24.00	30.7
10	3002P10 19V	27.00	33.7
11	3002P11 19V	30.00	36.7
12	3002P12 19V	33.00	39.7

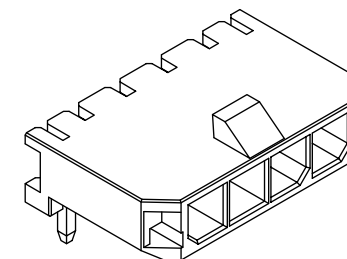

ISOMETRIC VIEW

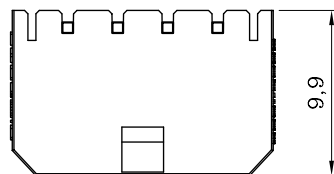
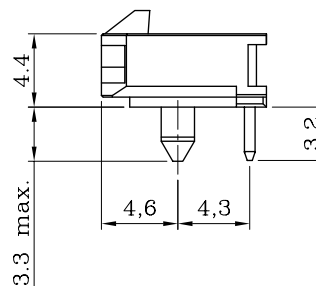
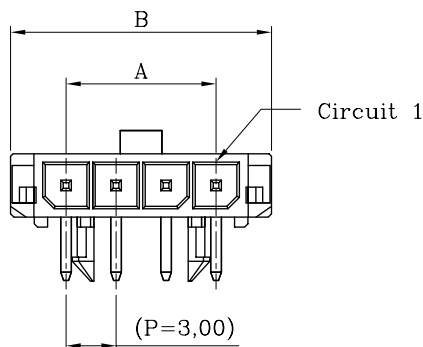

DESCRIPTION OF ORDER NO.:

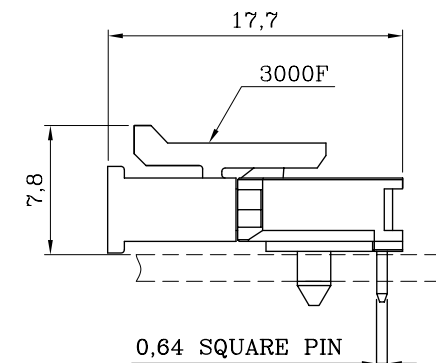
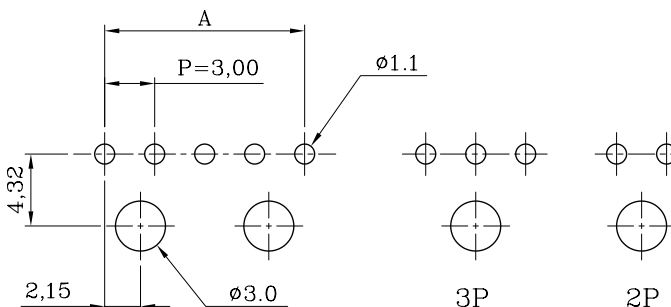
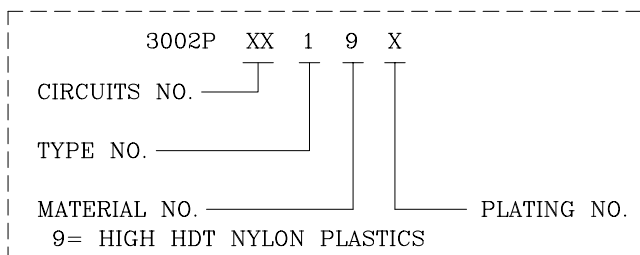

ASSEMBLY LAYOUT

NOTES:

- MATERIAL:
BASE: HIGH HDT NYLON 94V-0, BLACK COLOR
CONTACT PIN: BRASS
- MATES WITH 3000F SINGLE-ROW SERIES PLUG HOUSING.
- DESCRIPTION OF COLOR CODE:
LEGEND: 3002PXX19X-X (-X: COLOR CODE)
R=RED, E=BLUE, H=GRAY, M=GREEN, S=IVORY (NATURAL)
I=BRICK RED,
- REPLACEMENT OF HALOGEN-FREE PRODUCT:
LEGEND: 3002PXX19X-XNH (NH: HALOGEN-FREE)
LEGEND: 3002PXX19X-BNH (B=BLACK COLOR)
- INFORMATION IN THIS DRAWING IS NOT CONSIDERED AS FINAL.

DESCRIPTION OF PLATING CODE:	
V= MATTE TIN-PLATED	A= SELECT GOLD FLASH-PLATED

P.C. BOARD LAYOUT
(COMPONENT SIDE)



GWT 850 °C Rated Sales Drawing

MATERIAL: SEE NOTES	
FINISH(COLOR): SEE NOTES	
W1	NEW RELEASE
REV.	REVISION RECORD

聯盈電子股份有限公司 LANDWIN ELECTRONIC CORP.		GENERAL TOLERANCE:	PROJECTION	SCALE	UNIT	SHEET NO.	REV
		±3°	FREE	MM	1 / 1	W1	
DRAWN R.G.		DRAW NO.		3002PXX19X			
CHECKED J.L.Lin		TITLE:		3.00 PITCH SINGLE-ROW R/A HEADER (TYPE-1)			
APPD H.Y.Lin		DATE 31-DEC-14'					