

ORDER INFORMATION AND DIMENSION:

Circuits	Part No. (Matte tin, Ivory color)	Dimension	
		A	B
2	1252P0210T	1.25	7.3
3	1252P0310T	2.50	8.5
4	1252P0410T	3.75	9.8
5	1252P0510T	5.00	11.0
6	1252P0610T	6.25	12.3
7	1252P0710T	7.50	13.5
8	1252P0810T	8.75	14.8
9	1252P0910T	10.00	16.0
10	1252P1010T	11.25	17.3
11	1252P1110T	12.50	18.5
12	1252P1210T	13.75	19.8
13	1252P1310T	15.00	21.0
14	1252P1410T	16.25	22.3
15	1252P1510T	17.50	23.5

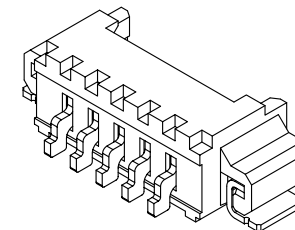
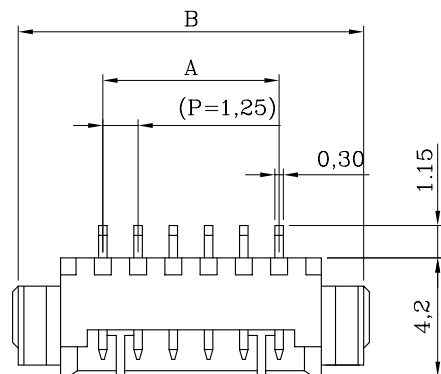

ISOMETRIC VIEW

DESCRIPTION OF ORDER NO.:

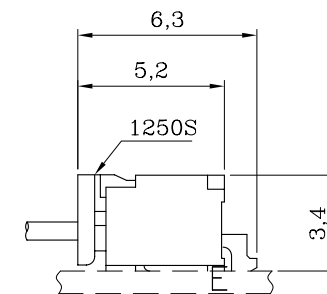
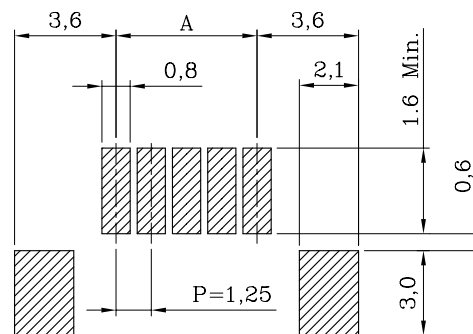
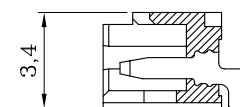
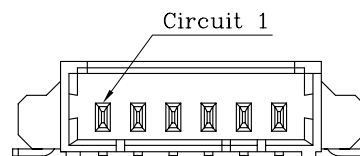
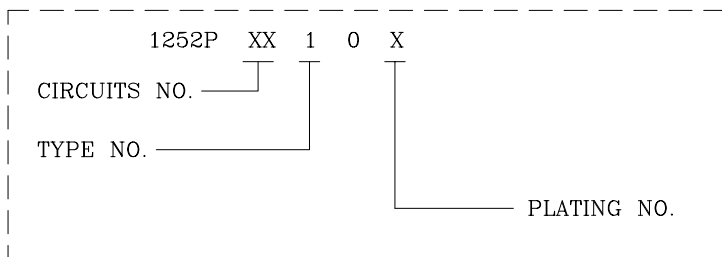

ASSEMBLY LAYOUT

NOTES:

- MATERIAL:
BASE: HIGH HDT NYLON 94V-0, IVORY COLOR (NATURAL)
CONTACT PIN: BRASS
- MATES WITH 1250S SINGLE-ROW SERIES PLUG HOUSING.
- DESCRIPTION OF COLOR CODE:
LEGEND: 1252PXX10X-X (-X: COLOR CODE)
B=BLACK, C=COCONUT BROWN, E=BLUE, H=GRAY,
I=BRICK RED, M=GREEN, R=RED, W=BROWN
- REPLACEMENT OF HALOGEN-FREE PRODUCT:
LEGEND: 1252PXX10X-XNH (NH: HALOGEN-FREE)
LEGEND: 1252PXX10X-SNH (S=NATURAL COLOR)
- Q'ty per 330 mm Dia. Panel: 1,000 PCS/Embossed Tape Reel
- INFORMATION IN THIS DRAWING IS NOT CONSIDERED AS FINAL.

P.C. BOARD LAYOUT



Sales Drawing

LANDWIN 聯盈電子股份有限公司
LANDWIN ELECTRONIC CORP.

MATERIAL: SEE NOTES		PROJECTION		SCALE	UNIT	SHEET NO.	REV
FINISH(COLOR): SEE NOTES		FREE		FREE	MM	1 / 1	W1
		DRAWN		R.G.	DRAW NO.		
		CHECKED		J.L.Lin	(CQ) 1252PXX10X		
		APPD		H.Y.Lin	TITLE:		
W1	NEW RELEASE	31-DEC-14'	ANGULAR ±3°	DATE 31-DEC-14'	1.25 PITCH RIGHT-ANGLE SINGLE-ROW SMT-HEADER		
REV.	REVISION RECORD	DATE					

DESCRIPTION OF PLATING CODE

T	MATTE TIN-PLATED	1	GOLD FLASH-PLATED
		A	SELECT GOLD FLASH-PLATED