

ORDER INFORMATION AND DIMENSION:

Circuits	Part No. (W/O Flange) (Black color)	Dimension	
		A	B
2	4200M02 A1-BA	n/a	5.40
4	4200M04 A1-BA	4.20	9.60
6	4200M06 A1-BA	8.40	13.80
8	4200M08 A1-BA	12.60	18.00
10	NOT AVAILABLE		
12	NOT AVAILABLE		
14	NOT AVAILABLE		
16	NOT AVAILABLE		
18	NOT AVAILABLE		
20	NOT AVAILABLE		
22	NOT AVAILABLE		
24	NOT AVAILABLE		

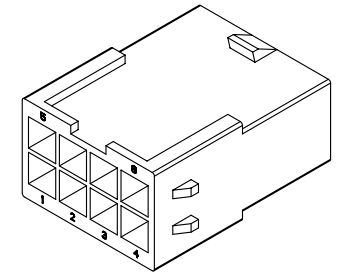

ISOMETRIC VIEW

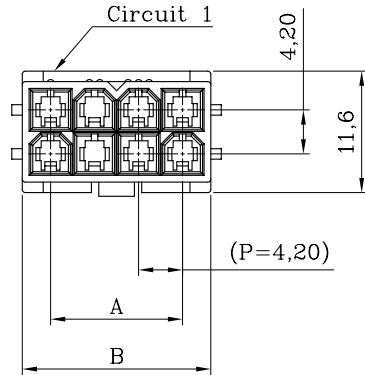
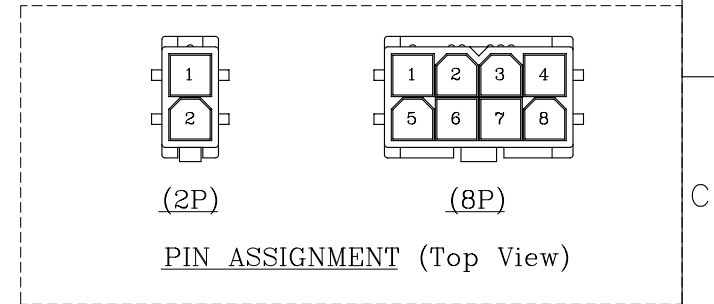

(2P)

(8P)

PIN ASSIGNMENT (Top View)

DESCRIPTION OF ORDER NO.:

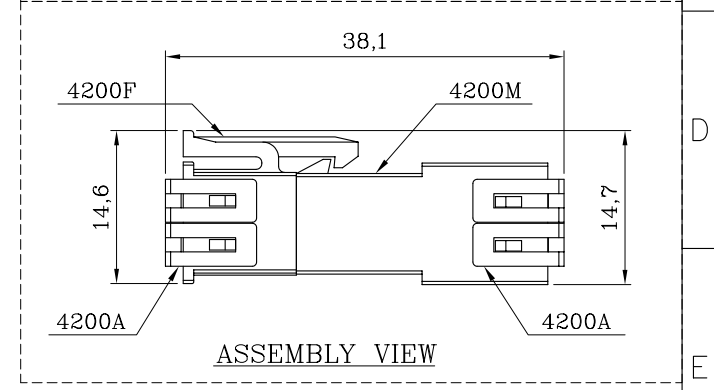
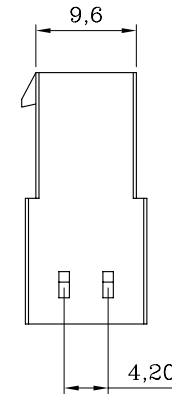
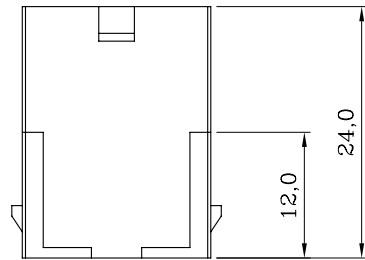
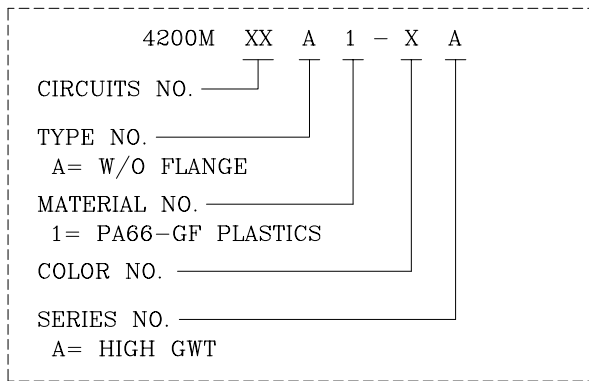

ASSEMBLY VIEW

NOTES:

- MATERIAL:
BASE: PA66-GF 94V-0
- USE WITH 4203TM SERIES CRIMP TERMINAL.
- MATES WITH 4200FXX01-XA SERIES PLUG HOUSING.
- DESCRIPTION OF COLOR NO.:
LEGEND: 4200MXXA1-XA (-X: COLOR CODE)
B=BLACK, E=BLUE, H=GRAY,
R=RED, S=LIGHT IVORY/NATURAL COLOR
- REPLACEMENT OF HALOGEN-FREE PRODUCT:
LEGEND: 4200MXXA1-XANH (NH: HALOGEN-FREE)
LEGEND: 4200MXXA1-BANH (B=BLACK COLOR)
- INFORMATION IN THIS DRAWING IS NOT CONSIDERED AS FINAL.



High GWT Rated Sales Drawing

MATERIAL: SEE NOTES		聯盈電子股份有限公司 LANDWIN ELECTRONIC CORP.		GENERAL TOLERANCE:	PROJECTION	SCALE	UNIT	SHEET NO.	REV
FINISH(COLOR): SEE NOTES				ANGULAR ±3°	FREE	MM	2 / 2	W1	
W1	NEW RELEASE	31-DEC-14'	DATE 31-DEC-14'	DRAWN R.G.		DRAW NO.			
REV.	REVISION RECORD	DATE	CHECKED J.L.Lin		(AQ) 4200MXXX1-XA				
			APPD H.Y.Lin		TITLE:				
					4.20 PITCH DUAL-ROW RECEPTACLE HOUSING				