

ORDER INFORMATION AND DIMENSION:

Circuits	Part No. (Reflow tin, White color)	Dimension	
		A	B
2	2002P02 00T	2.0	6.0
3	2002P03 00T	4.0	8.0
4	2002P04 00T	6.0	10.0
5	2002P05 00T	8.0	12.0
6	2002P06 00T	10.0	14.0
7	2002P07 00T	12.0	16.0
8	2002P08 00T	14.0	18.0
9	2002P09 00T	16.0	20.0
10	2002P10 00T	18.0	22.0
11	2002P11 00T	20.0	24.0
12	2002P12 00T	22.0	26.0
13	2002P13 00T	24.0	28.0
14	2002P14 00T	26.0	30.0
15	2002P15 00T	28.0	32.0
16	2002P16 00T	30.0	34.0

DESCRIPTION OF ORDER NO.:

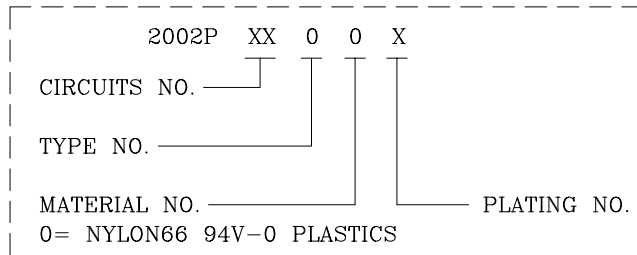

NOTES:

- MATERIAL:
BASE: NYLON66 94V-0, WHITE COLOR (NATURAL)
CONTACT PIN: BRASS
- MATES WITH 2001S SINGLE-ROW SERIES PLUG HOUSING.
- DESCRIPTION OF COLOR CODE:
LEGEND: 2002PXX00X-X (-X: COLOR CODE)
B=BLACK, C=COCONUT BROWN, D=ORANGE, E=BLUE, H=GRAY,
I=BRICK RED, K=PURPLE, L=LEMON YELLOW, M=GREEN,
P=PINK, R=RED, V=LAVENDER, W=BROWN, Y=YELLOW
- INFORMATION IN THIS DRAWING IS NOT CONSIDERED AS FINAL.

DESCRIPTION OF PLATING CODE

T	REFLOW TIN-PLATED	1	GOLD FLASH-PLATED
---	-------------------	---	-------------------

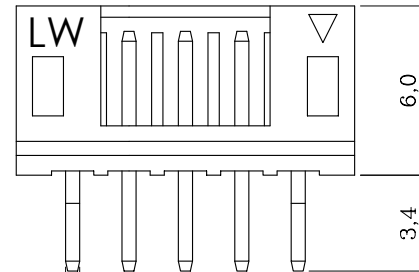
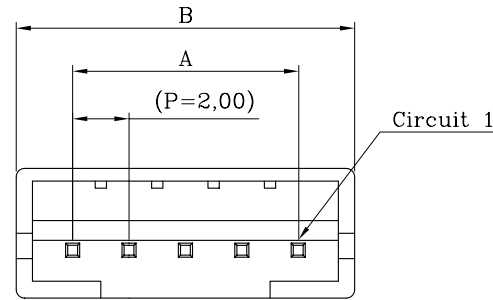

0,50 SQUARE PIN

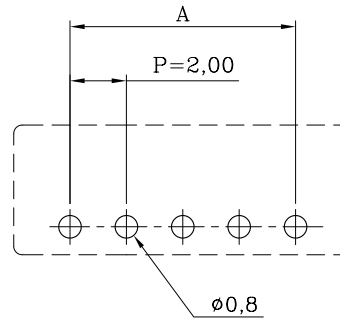

P.C. BOARD LAYOUT

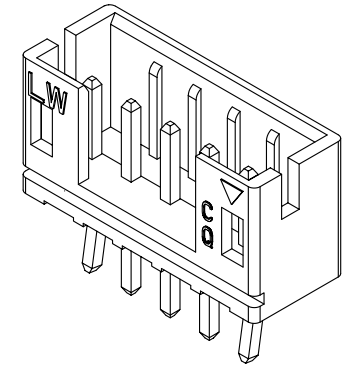
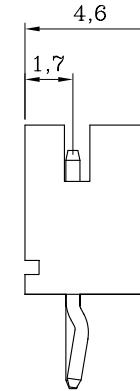

ISOMETRIC VIEW

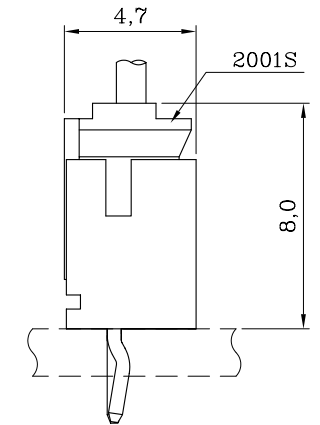

ASSEMBLY LAYOUT



Sales Drawing



聯盈電子股份有限公司
LANDWIN ELECTRONIC CORP.

MATERIAL: SEE NOTES		FINISH(COLOR): SEE NOTES	
W1	NEW RELEASE	31-DEC-14'	ANGULAR $\pm 3^\circ$
REV.	REVISION RECORD	DATE	

GENERAL TOLERANCE:	PROJECTION	SCALE	UNIT	SHEET NO.	REV
		FREE	MM	1 / 1	W1
	DRAWN R.G.	DRAW NO.			
	CHECKED J.L.Lin	(CQ) 2002PXX00X			
	APPD H.Y.Lin	TITLE:			
	DATE 31-DEC-14'	2.00 PITCH SINGLE-ROW STRAIGHT DIP-HEADER			